

Article datasheet

**Pan Head Screw ISO1580 M8x50 Polyamide 6.6 Natural Slotted**

Article-No.: 001.45.7070



Image may be similar

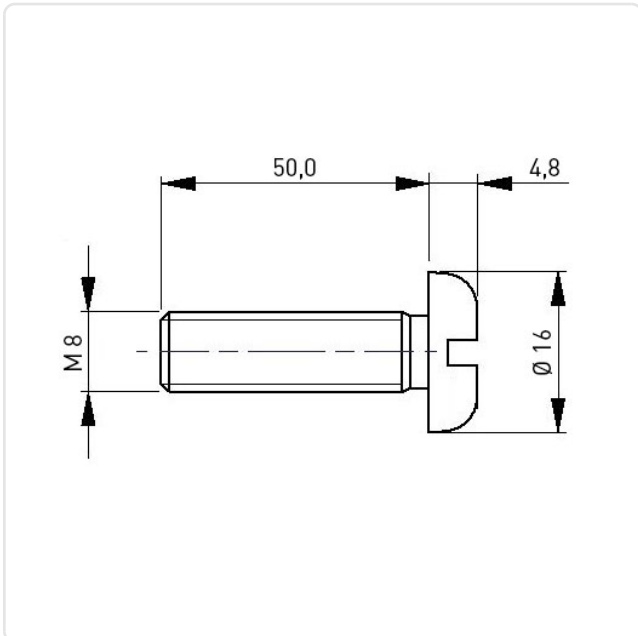

Color:	Natural
DIN/ISO:	ISO1580
Drive Type:	Slotted
Head Diameter [mm]:	16
Head Height [mm]:	4.8
Head Shape:	Pan Head
Length [mm]:	50
Material:	PA 6.6
Material Group:	Plastic
Thread Size:	M8
Weight:	2.96g
Conformities:	



You can find all information on the web on our article detail page

[Pan Head Screw ISO1580 M8x50 Polyamide 6.6 Natural Slotted](#)

Would you like individual advice?

We look forward to your email to [products@ettinger.de](mailto:products@ettinger.de).

Subject to change and errors.