

Article datasheet

Pan Head Screw ISO7045 M2.5x8 Stainless Steel A4 Cross Recessed

Article-No.: 001.18.239



Image may be similar

Actuator Size:	Pozidriv PZ1
DIN/ISO:	ISO7045
Drive Type:	Cross Recess / Pozidriv-Z
Finish:	Plain
Head Diameter [mm]:	5
Head Height [mm]:	2.1
Head Shape:	Pan Head
Length [mm]:	8
Material:	Stainless Steel AISI 316 / A4
Material Group:	Stainless Steel
Thread Size:	M2.5
Weight:	0.44g
Conformities:	

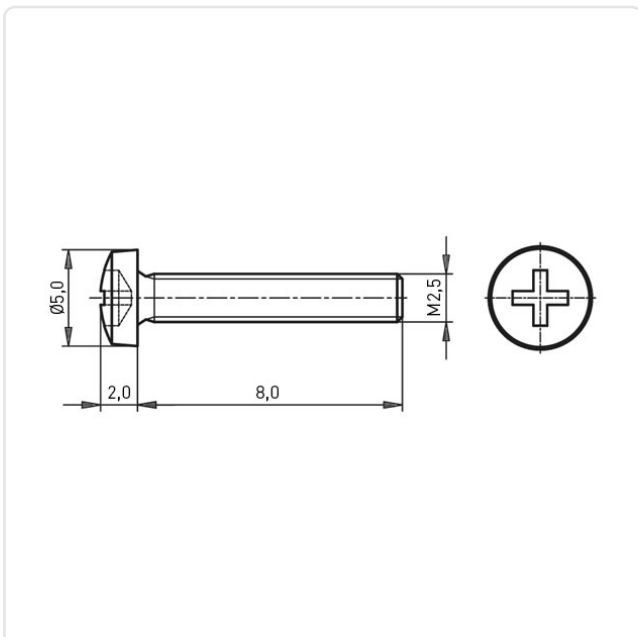

You can find all information on the web on our article detail page

[Pan Head Screw ISO7045 M2.5x8 Stainless Steel A4 Cross Recessed](#)

Would you like individual advice?

We look forward to your email to products@ettinger.de.

Subject to change and errors.