

Article datasheet

Countersunk Screw ISO7047 M4x12 Nickel-Plated Steel 4.8 Cross Recessed

Article-No.: 001.12.457

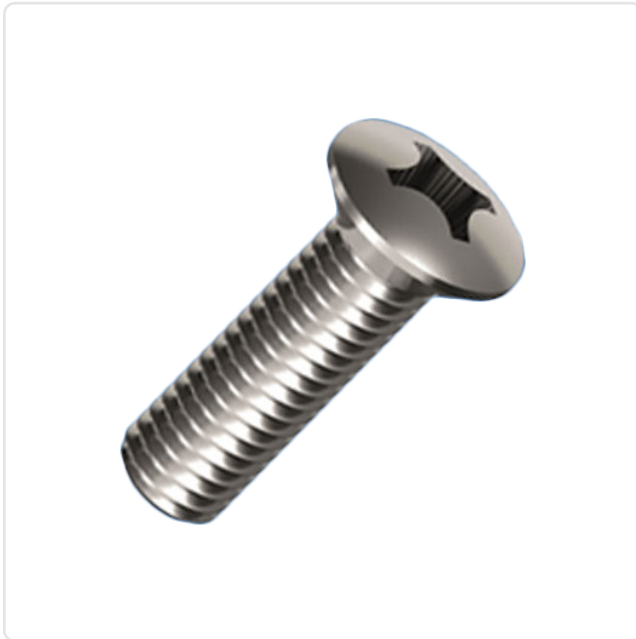
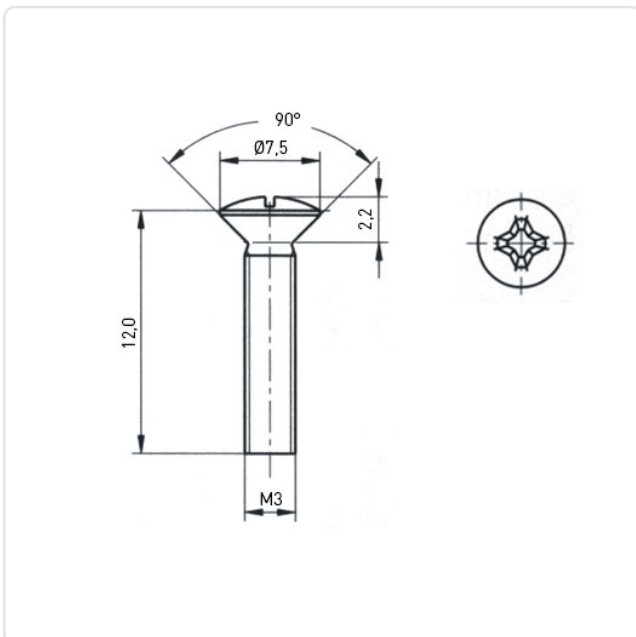

Image may be similar

Actuator Size:	Phillips PH2
DIN/ISO:	ISO7047
Drive Type:	Cross Recess / Phillips-H
Finish:	Nickel-Plated, 3 µm, E1E
Head Diameter [mm]:	7.5
Head Height [mm]:	2.2
Head Shape:	Countersunk Head
Length [mm]:	12
Material:	Steel 4.8
Material Group:	Stahl
Thread Size:	M4
Weight:	1.2g
Conformities:	



You can find all information on the web on our article detail page

[Countersunk Screw ISO7047 M4x12 Nickel-Plated Steel 4.8 Cross Recessed](#)

Would you like individual advice?

We look forward to your email to products@ettinger.de.

Subject to change and errors.